

Name: _____ Date: _____ Event: _____

Track: Indoor Outdoor Size: Small Medium Large Traction: Low Med High

Surface: Smooth Bumpy Rutted Type: Loose/Loamy Hard Pack Blue Groove Clay

Bumpsteer/Ackerman/Servo Saver/Steering Stop: _____ Condition: Dusty Dry Wet Muddy

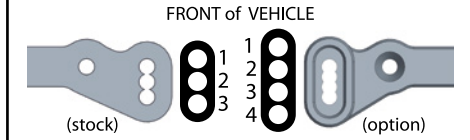

Shocks:

	FRONT	REAR
OIL		
BRAND		
PISTON		
SPRING		
REBOUND	%	%
STD/EMUL/VENT		
NOTES:		

Front End:

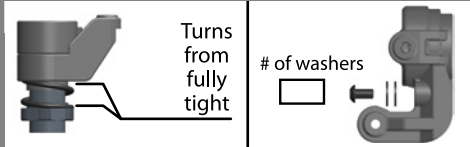
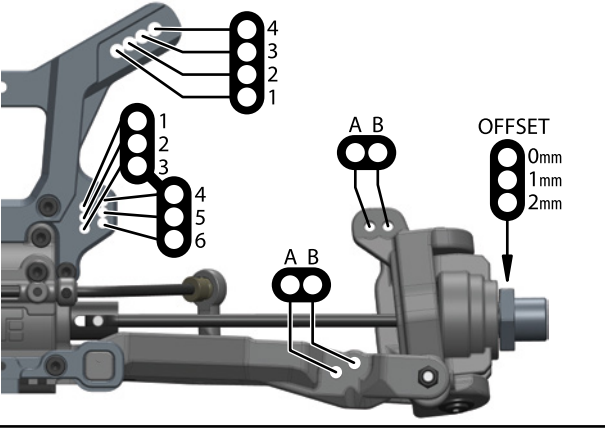

Suspension:

	FRONT	REAR
RIDE HEIGHT		
CAMBER		
CASTER		
SWEEP		
KICK UP		
ANTI-SQUAT		
TOE (in/out)		
SWAY BAR		
SHOCK LENGTH (DROOP)		

Tires / Wheels:

	FRONT	REAR
BRAND/TREAD		
COMPOUND		
INSERT		
WHEEL		
NOTES:		

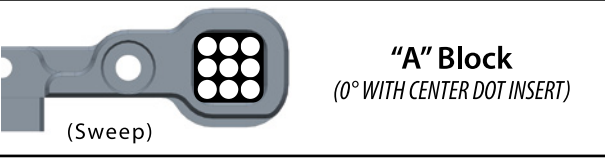

Differential Oil:

	FRONT	CENTER	REAR

Rear End:

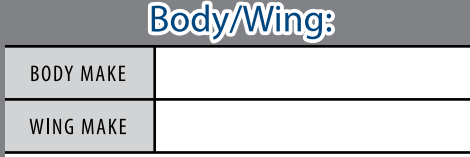
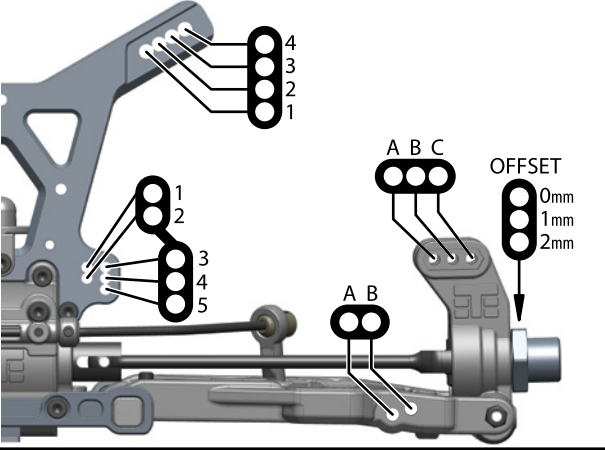

Body/Wing:

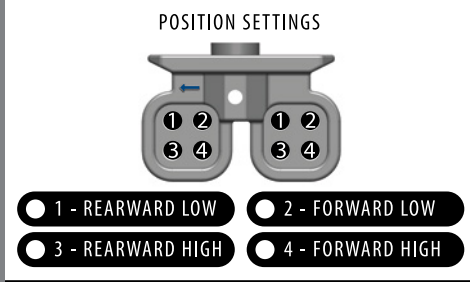

Electronics:

ESC:	
BATTERY:	
MOTOR:	
RADIO:	
SERVO:	

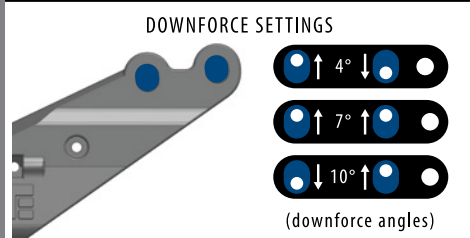
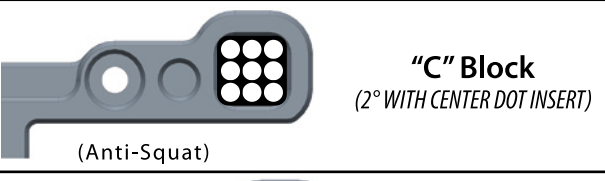

Drivetrain:

PINION SIZE		(teeth)
-------------	--	---------



Wheelbase:

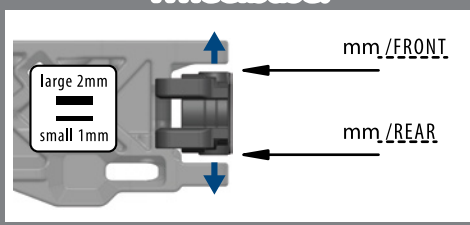

Chassis Braces:

Front <input type="radio"/>	Middle <input type="radio"/>	Rear <input type="radio"/>
(front brace is always recommended)		



Notes:
